

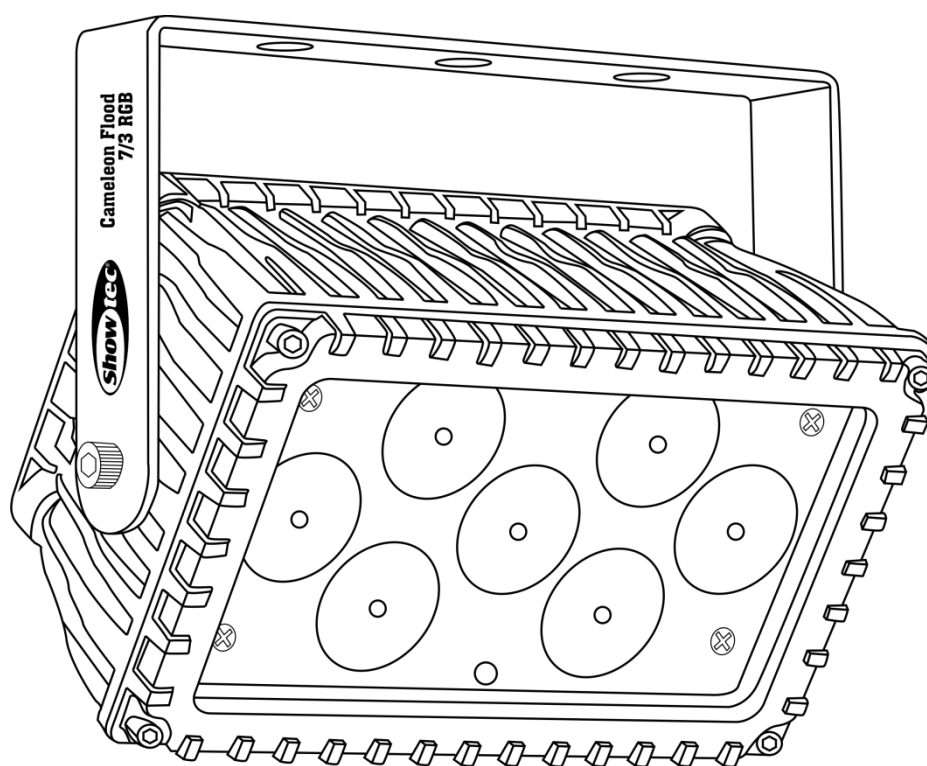

MANUAL



ENGLISH

Cameleon Flood 7/3RGB V2

Ordercode: 42689

Table of contents

Warning	2
Safety Instructions	2
Operating Determinations	4
Rigging	4
Connection with the mains.....	5
Return Procedure	6
Claims.....	6
Description of the device	7
Optional accessories.....	7
Frontside.....	8
Backside	8
Installation	9
Set Up and Operation	9
Control Modes.....	9
One Cameleon Flood (Auto Run Mode)	9
One Cameleon Flood (Built-in programs)	9
One Cameleon Flood (Static color)	9
One Cameleon Flood (Manual color)	9
One Cameleon Flood (NO Sound-control).....	9
Multiple Cameleon Floods (Master/Slave control)	10
Multiple Cameleon Floods (DMX Control)	10
Fixture Linking.....	12
Data Cabling.....	12
DMX Control Mode.....	12
DMX Addressing.....	12
Operation via the remote (42704) not included	13
1. Built-in Auto-run mode.....	14
2. Built-in programs.....	14
3. Sound-controlled mode (no function)	14
4. DMX Mode.....	14
5. Slave mode	15
6. Static color mode.....	15
7. Manual color mode.....	15
8. Factory Reset	15
DMX Channels.....	16
3 DMX Channels.....	16
Maintenance	16
Troubleshooting	16
No Light	16
No Response to DMX.....	17
Product Specifications	18
Dimensions	18
Notes	20

Warning



**For your own safety, please read this user manual carefully
before your initial start-up!**



Unpacking Instructions

Immediately upon receiving this product, carefully unpack the carton and check the contents to ensure that all parts are present, and have been received in good condition. Notify the dealer immediately and retain packing material for inspection if any parts appear damaged from shipping or the carton itself shows signs of mishandling. Save the carton and all packing materials. In the event that a fixture must be returned to the factory, it is important that the fixture be returned in the original factory box and packing.

Your shipment includes:

- Showtec Cameleon Flood 7/3 RGB
- 1x Schuko to 3-pins (IP-65) Power cable 1,5m
- 2 End cap sets male/female for Power and DMX
- User manual

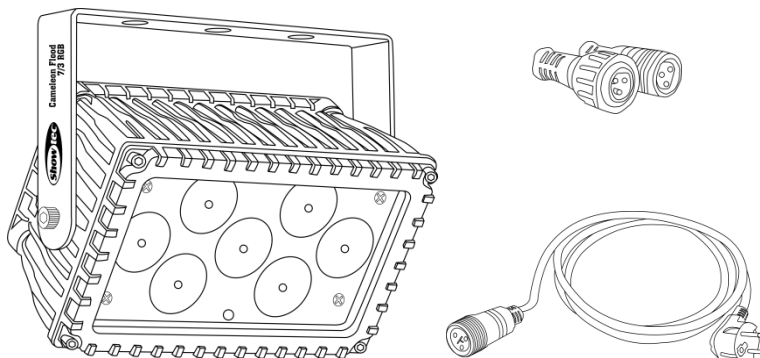

LED Expected Lifespan

LEDs gradually decline in brightness over time. HEAT is the dominant factor that leads to the acceleration of this decline. Packaged in clusters, LEDs exhibit higher operating temperatures than in ideal or singular optimum conditions. For this reason, when all color LEDs are used at their fullest intensity, life of the LEDs is significantly reduced. If improving the lifespan is of higher priority, place care in providing for lower operational temperatures. This may include climatic-environmental and the reduction of overall projection intensity.



CAUTION!

**Keep this device away from rain and moisture!
Unplug mains lead before opening the housing!**



Safety Instructions

Every person involved with the installation, operation and maintenance of this device has to:

- be qualified
- follow the instructions of this manual



**CAUTION! Be careful with your operations.
With a dangerous voltage you can suffer
a dangerous electric shock when touching the wires!**



Before the initial start-up, please make sure that there is no damage caused by transportation. Should there be any, consult your dealer and do not use the device.

To maintain perfect condition and to ensure a safe operation, it is absolutely necessary for the user to follow the safety instructions and warning notes contained in this manual.

Please consider that damages caused by manual modifications to the device are not subject to warranty.

This device contains no user-serviceable parts. Refer servicing to qualified technicians only.

IMPORTANT:

The manufacturer will not accept liability for any resulting damages caused by the non-observance of this manual or any unauthorized modification to the device.

- Never let the power cord come into contact with other cables! Handle the power cord and all connections with the mains with particular caution!
- Never remove warning or informative labels from the unit.
- Never use anything to cover the ground contact.
- Never lift the fixture holding it by the projector-head, as the mechanics may be damaged. Always hold the fixture by the transport handles.
- Never place any material over the lens.
- Never look directly into the light source.
- Never leave any cables lying around.
- Never loosen the screws of the rotating gobo otherwise you risk opening of the ball bearing.
- Do not insert objects into air vents.
- Do not connect this device to a dimmerpack.
- Do not switch the device on and off in short intervals, as this will reduce the device's life.
- Do not touch the device's housing bare-handed during its operation (housing becomes very hot). Allow the fixture to cool for at least 5 minutes before handling.
- Do not shake the device. Avoid brute force when installing or operating the device.
- Only use the device indoors, avoid contact with water or other liquids.
- Only operate the fixture after having checked if the housing is firmly closed and all screws are tightly fastened.
- Only operate the device after having familiarized with its functions.
- Avoid flames and do not put close to flammable liquids or gases.
- Always keep the case closed while operating.
- Always allow a free air space of at least 50 cm around the unit for ventilation.
- Always disconnect power from the mains, when device is not used or before cleaning! Only handle the power cord holding it by the plug. Never pull out the plug by tugging the power cord.
- Make sure that the device is not exposed to extreme heat, moisture or dust.
- Make sure that the available voltage is not higher than stated on the rear panel.
- Make sure that the power cord is never crimped or damaged. Check the device and the power cord from time to time.
- If the lens is obviously damaged, it has to be replaced.
- If device was dropped or struck, disconnect mains power supply immediately. Have a qualified engineer inspect for safety before operating.
- If the device has been exposed to drastic temperature fluctuation (e.g. after transportation), do not switch it on immediately. The arising condensation water might damage your device. Leave the device switched off until it has reached room temperature.
- If your Showtec device fails to work properly, discontinue the use immediately. Pack the unit securely (preferably in the original packing material), and return it to your Showtec dealer for service.
- For adult use only. The fixture must be installed beyond the reach of children. Never leave the unit running unattended.
- Never attempt to bypass the thermostatic switch or fuses.
- For replacement use fuses of same type and rating only.

- The user is responsible for correct positioning and operating of the Cameleon Flood 7/3 RGB. The manufacturer will not accept liability for damages caused by the misuse or incorrect installation of this device.
- This device falls under protection class I. Therefore it is essential to connect the yellow/green conductor to earth.
- Repairs, servicing and electric connection must be carried out by a qualified technician.
- WARRANTY: Till one year after date of purchase.

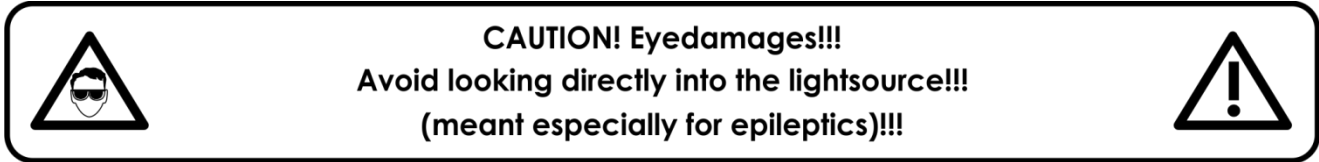

Operating Determinations

- This device is not designed for permanent operation. Consistent operation breaks will ensure that the device will serve you for a long time without defects.
- The minimum distance between light output and the illuminated surface must be bigger than 1 meter.
- The maximum ambient temperature $t_a = 40^\circ\text{C}$ must never be exceeded.
- The relative humidity must not exceed 50 % with an ambient temperature of 40°C .
- If this device is operated in any other way than the one described in this manual, the product may suffer damages and the warranty becomes void.
- Any other operation may lead to dangers like short-circuit, burns, electric shock, crash, etc.

You endanger your own safety and the safety of others!

Rigging

Please follow the European and national guidelines concerning rigging, trussing and all other safety issues.

Do not attempt the installation yourself !

Always let the installation be carried out by an authorized dealer !

Procedure:

- If the Cameleon Flood is lowered from the ceiling or high joists, professional trussing systems have to be used.
- Use a clamp to mount the Cameleon Flood, with the mounting bracket, to the trussing system.
- The Cameleon Flood must never be fixed swinging freely in the room.
- The installation must always be secured with a safety attachment, e.g. an appropriate safety net or safety cable.
- When rigging, derigging or servicing the Cameleon Flood, always make sure, that the area below the installation site is secured and that there are not any unauthorized people around.

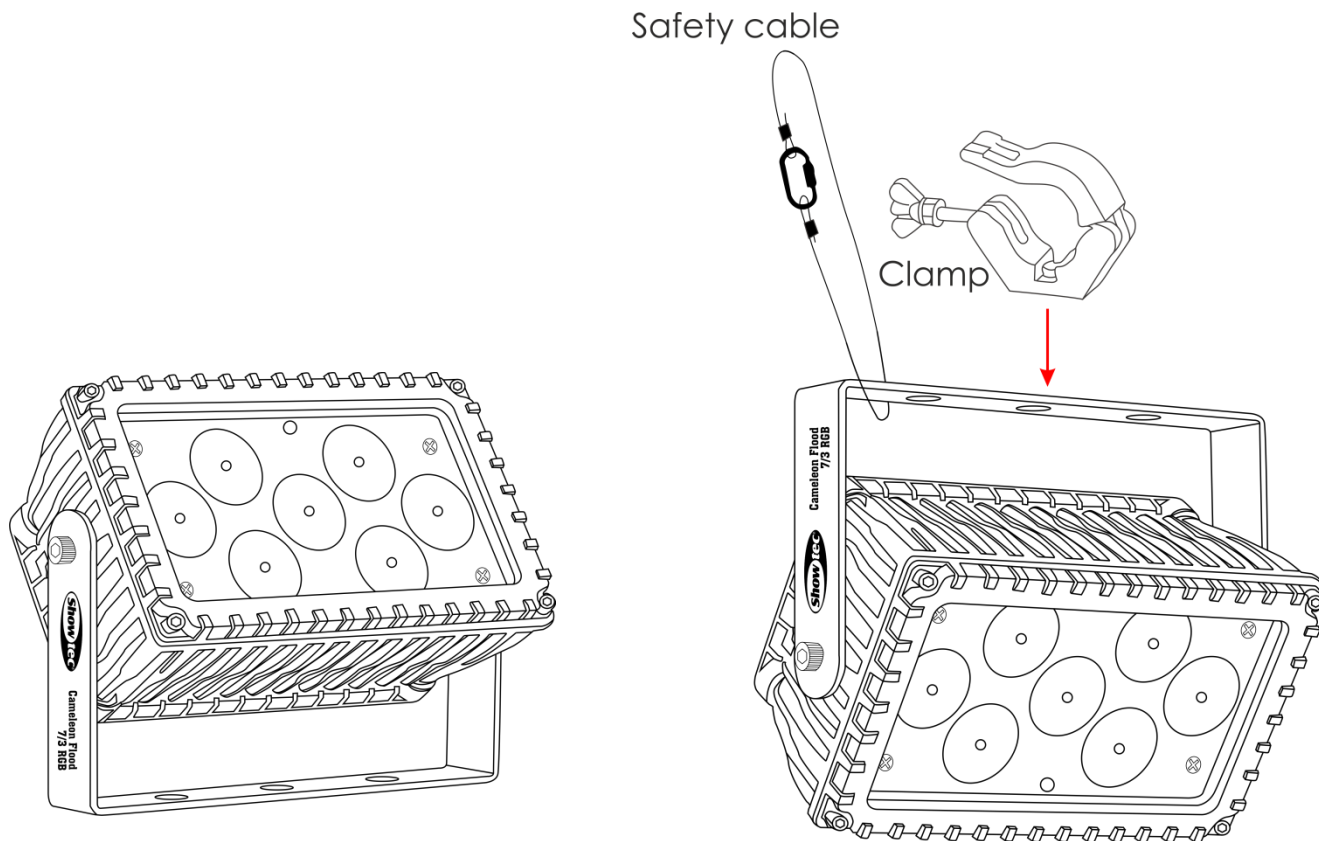

The Cameleon Flood 7/3 RGB can be placed on a flat stage floor or mounted to any kind of truss with a clamp.

Improper installation can cause serious injuries and/or damage of property!

Connection with the mains

Connect the device to the mains with the power-plug.
Always check if the right color cable is connected to the right place.

International	EU Cable	UK Cable	US Cable	Pin
L	BROWN	RED	YELLOW/COPPER	PHASE
N	BLUE	BLACK	SILVER	NEUTRAL
⊕	YELLOW/GREEN	GREEN	GREEN	PROTECTIVE GROUND

Make sure that the device is always properly connected to the earth!

Improper installation can cause serious injuries and/or damage of property!





Return Procedure



Returned merchandise must be sent prepaid and in the original packing, call tags will not be issued. Package must be clearly labeled with a Return Authorization Number (RMA number). Products returned without an RMA number will be refused. Highlite will not accept the returned goods or any responsibility. Call Highlite 0031-455667723 or mail aftersales@highlite.nl and request an RMA prior to shipping the fixture. Be prepared to provide the model number, serial number and a brief description of the cause for the return. Be sure to properly pack fixture, any shipping damage resulting from inadequate packaging is the customer's responsibility. Highlite reserves the right to use its own discretion to repair or replace product(s). As a suggestion, proper UPS packing or double-boxing is always a safe method to use.

Note: If you are given an RMA number, please include the following information on a piece of paper inside the box:

- 01) Your name
- 02) Your address
- 03) Your phone number
- 04) A brief description of the symptoms

Claims

The client has the obligation to check the delivered goods immediately upon delivery for any shortcomings and/or visible defects, or perform this check after our announcement that the goods are at their disposal. Damage incurred in shipping is the responsibility of the shipper; therefore the damage must be reported to the carrier upon receipt of merchandise.

It is the customer's responsibility to report and submit claims with the shipper in the event that a fixture is damaged due to shipping. Transportation damage has to be reported to us within one day after receipt of the delivery.

Any return shipment has to be made post-paid at all times. Return shipments must be accompanied with a letter defining the reason for return shipment. Non-prepaid return shipments will be refused, unless agreed otherwise in writing.

Complaints against us must be prepared in writing or sent by fax within 10 working days after receipt of the invoice. After this period complaints will not be handled anymore.

Complaints will only then be considered if the client has so far complied with all parts of the agreement, regardless of the agreement from which the obligation is resulting.

Description of the device

Features

The Cameleon Flood 7/3 RGB is an economical but eco-friendly wall washer. It is an extension on our Cameleon series. It's an indoor and outdoor solution for illumination of numerous objects.

- Control: IR remote ([42704](#)), not included !
- XLR 3-pin to mini 3-pin cable ([42708](#)) to connect the Cameleon to DMX, not included!
- Stylish design
- High Power Lightoutput
- Input voltage: 100-240V, 50/60Hz Autoswitch
- Power consumption: 21W
- DMX Mode: 3 Channels
- Colour range: 16,7 million additive colors
- RGB Colormixing
- Convection cooling which eliminates the use of fans and noise
- Light source: 7x 3-in-1 3W RGB LEDs
- Beam Angle: 40°
- Protection rate: IP-65
- Lens Plate: Tempered Glass
- Control: DMX / Auto Program / Built-in programs / Master-slave/ IR remote
- Dimmer: 0-100%
- Strobe: 0-20Hz
- Housing: Die Cast Aluminum
- Black Powder Coat Finish
- Cooling: Convection (no fans)
- Connections: Dedicated Power cable IP-65 IN/OUT & Data IP-65 IN/OUT
- Dimensions: 170 x 70 x 128 mm (LxWxH incl. bracket)
- Weight: 1,1 kg

Optional accessories

[42698](#) Power end cap set Male/female for Cameleon series

[42699](#) Data end cap set Male/female for Cameleon series

[42704](#) Infra Red Controller for Cameleon Series (necessary for controlling the device!)

[42705](#) Power Extension cable for Cameleon series (3m)

[42706](#) Power connection cable for Cameleon series (3m)

[42707](#) DMX Extension cable for Cameleon series (3m)

[42708](#) DMX Input cable for Cameleon series (3m)



Please make sure to obtain the XLR 3-pin to mini 3-pin cable ([42708](#)) to connect the device to DMX. Please make sure to also obtain the remote control ([42704](#)) to control the device.

Frontside

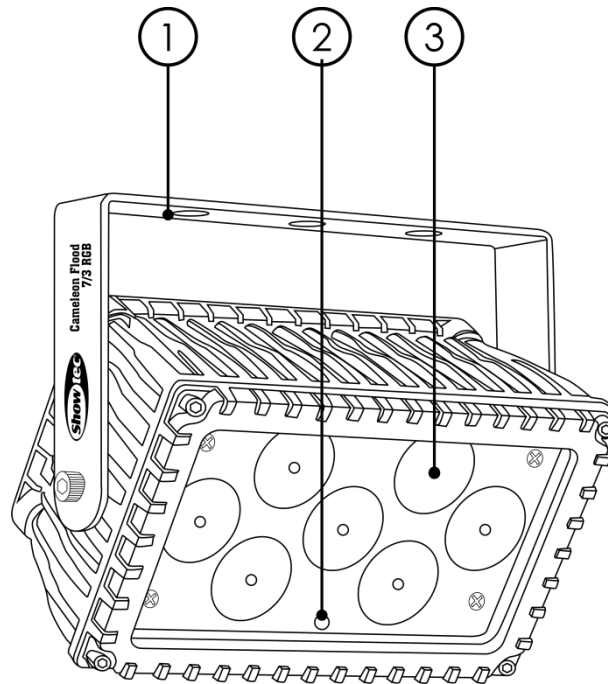

Fig. 01

- 01) Mounting bracket
- 02) Infrared sensor for remote control
- 03) 7x 3-in-1 3W RGB LEDs

Backside

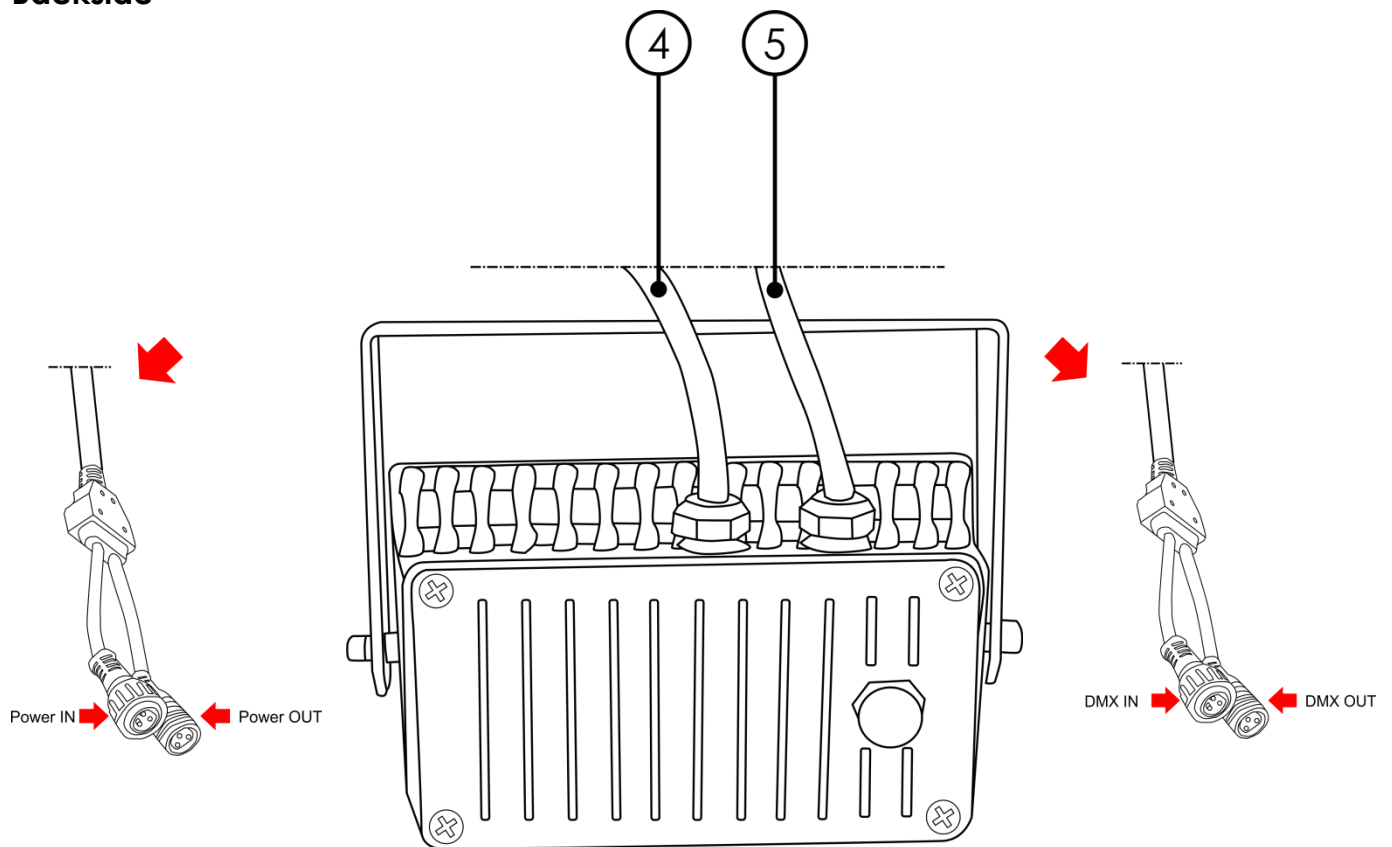

Fig. 02

- 04) Special mini 3-pin power cable IN/OUT IP-65
- 05) Special mini 3-pin DMX cable IN/OUT IP-65

Installation

Remove all packing materials from the Cameleon Flood 7/3 RGB. Check if all foam and plastic padding is removed. Connect all cables.

Do not supply power before the whole system is set up and connected properly.

Always disconnect from electric mains power supply before cleaning or servicing.

Damages caused by non-observance are not subject to warranty.



Please make sure to also obtain the remote control ([42704](#)), because this is necessary to control the device.

Set Up and Operation

Follow the directions below, as they pertain to your preferred operation mode.

Before plugging the unit in, always make sure that the power supply matches the product specification voltage. Do not attempt to operate a 120V specification product on 230V power, or vice versa.

Control Modes

There are 7 modes:

- Auto run
- Built-in programs
- Static Color mode
- Manual Color mode
- Sound-active (No function)
- Master/slave
- DMX-512 (3CH)

One Cameleon Flood (Auto Run Mode)

- 01) Fasten the effect light onto firm trussing. Leave at least 0,5 meter on all sides for air circulation.
- 02) Plug the end of the electric mains power cord into a proper electric power supply socket.
- 03) When the Cameleon Flood is not connected with a DMX cable, it functions as a stand-alone device. Please see page 14 for more information about the Auto run visual effects.

One Cameleon Flood (Built-in programs)

- 01) Fasten the effect light onto firm trussing. Leave at least 0,5 meter on all sides for air circulation.
- 02) Plug the end of the electric mains power cord into a proper electric power supply socket.
- 03) When the Cameleon Flood is not connected with a DMX cable, it functions as a stand-alone device. Please see page 14 for more information about the Built-in programs.

One Cameleon Flood (Static color)

- 04) Fasten the effect light onto firm trussing. Leave at least 0,5 meter on all sides for air circulation.
- 05) Plug the end of the electric mains power cord into a proper electric power supply socket.
- 06) When the Cameleon Flood is not connected with a DMX cable, it functions as a stand-alone device. Please see page 15 for more information about the Static color control.

One Cameleon Flood (Manual color)

- 07) Fasten the effect light onto firm trussing. Leave at least 0,5 meter on all sides for air circulation.
- 08) Plug the end of the electric mains power cord into a proper electric power supply socket.
- 09) When the Cameleon Flood is not connected with a DMX cable, it functions as a stand-alone device. Please see page 15 for more information about the Manual color control.

One Cameleon Flood (NO Sound-control))

Although the remote control says Sound-active, it won't function with this device, because this is an outdoor device.

Multiple Cameleon Floods (Master/Slave control)

- 01) Fasten the effect light onto firm trussing. Leave at least 0,5 meter on all sides for air circulation.
- 02) Use a 3-p XLR cable to connect the Cameleon Floods and other devices.

The pins:



1. Earth
2. Signal (-)
3. Signal (+)

- 03) Link the units as shown in Fig. 03. Connect the first unit's DMX "out" socket with the second unit's "in" socket, using the **42707** – DMX Extension cable. Link the second, third, and fourth units using the **42707** – DMX Extension cable.

You can use the same functions on the master device as described on pages 14 and 15 (Auto run mode, Built-in programs, Static color, Manual color). This means that you can set your desired operation mode on the master device and all slave devices will react the same as the master device.

Multiple Cameleon Floods (Master/Slave control)

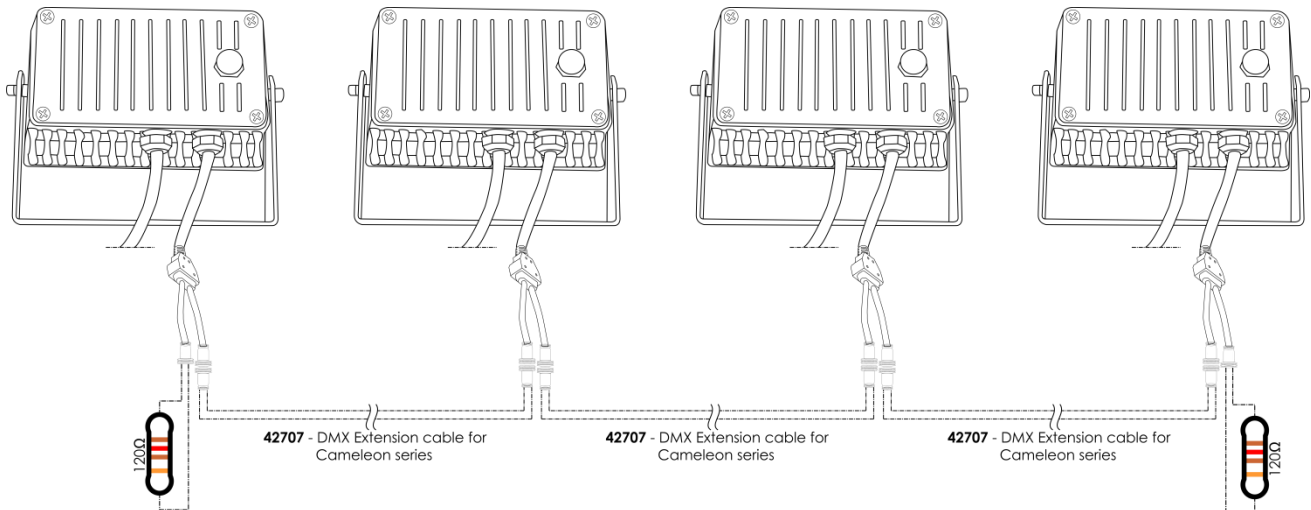

Fig. 03

Multiple Cameleon Floods (DMX Control)

- 01) Fasten the effect light onto firm trussing. Leave at least 0,5 meter on all sides for air circulation.
- 02) Use a 3-pin XLR cable to connect the Cameleon Floods and other devices.



- Pin 1: GND (screen)
- Pin 2: Signal (-)
- Pin 3: Signal (+)
- Pin 4: N/C
- Pin 5: N/C

- Pin 1: GND (screen)
- Pin 2: Signal (-)
- Pin 3: Signal (+)



- Pin 1: GND (screen)
- Pin 2: Signal (-)
- Pin 3: Signal (+)

- Pin 1: GND (screen)
- Pin 2: Signal (-)
- Pin 3: Signal (+)
- Pin 4: N/C
- Pin 5: N/C

- 03) Link the units as shown in fig. 04. Connect a light controller to the first unit's DMX "in" socket, using the **42708** – DMX input cable. Connect the first unit's "out" socket with the second unit's "in" socket, using the **42707** – DMX Extension cable, Link the second, third, and fourth units using the **42707** – DMX Extension cable.
- 04) Supply electric power: Plug electric mains power cords into each unit's special IP65 power IN socket, then plug the other end of the mains power cord into proper electric power supply sockets, starting with the first unit. Do not supply power before the whole system is set up and connected properly.

Multiple Cameleon Floods DMX Set Up

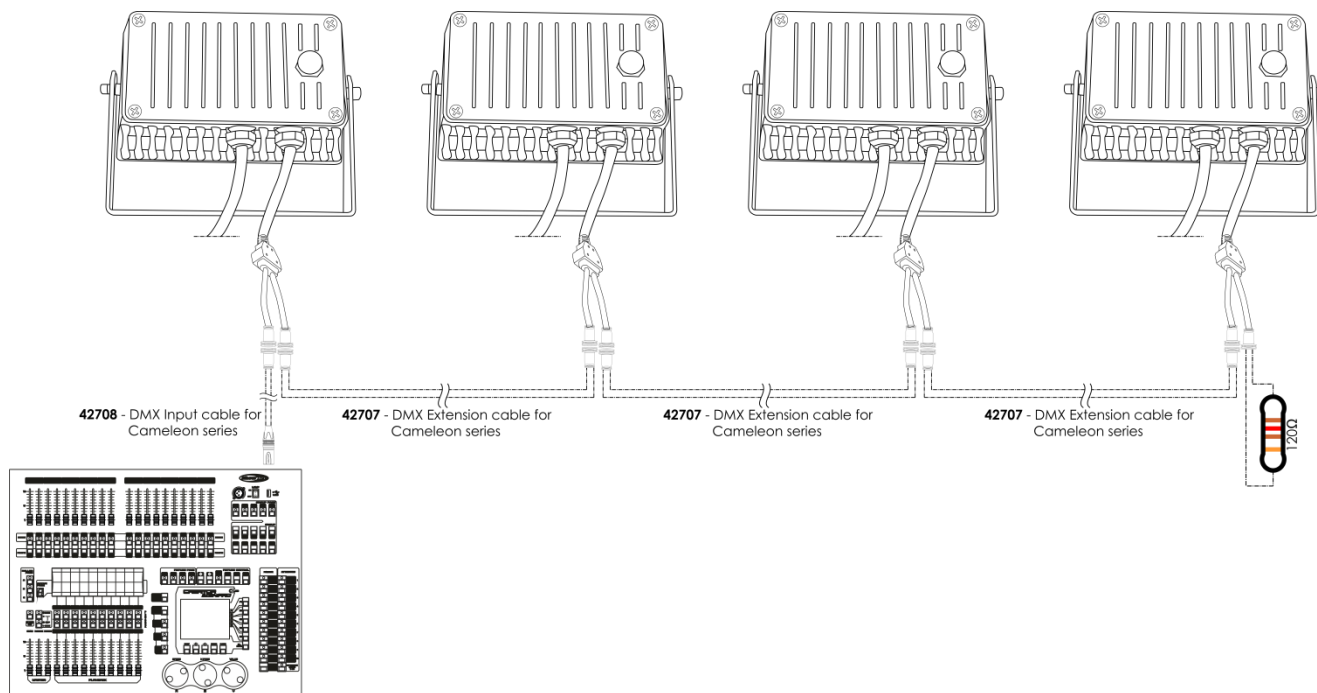

Fig. 04

Note : Link all cables before connecting electric power



Note: You cannot plug a standard DMX cable directly into the connector. Be sure to use the special cables for DMX connection ([42708](#)) and extension cables ([42707](#)).



Fixture Linking

You will need a serial data link to run light shows of one or more fixtures using a DMX-512 controller or to run synchronized shows of two or more fixtures set to a master/slave operating mode. The combined number of channels required by all the fixtures on a serial data link determines the number of fixtures the data link can support.

Important: Fixtures on a serial data link must be daisy-chained in a single line. To comply with the EIA-485 standard, no more than 30 devices should be connected on one data link. Connecting more than 30 fixtures on one serial data link without the use of a DMX optically isolated splitter may result in deterioration of the digital DMX signal.
Maximum recommended DMX data link distance: 100 meters
Maximum recommended number of fixtures on a DMX data link: 30 fixtures



Data Cabling

To link fixtures together, you must obtain data cables. You can purchase DAP Audio certified DMX cables directly from a dealer/distributor or construct your own cable. If you choose to create your own cable, please use data-grade cables that can carry a high quality signal and are less prone to electromagnetic interference.

DAP Audio DMX Data Cables

- DAP Audio Basic microphone cable for allround use. bal. XLR/M 3-pin > XLR/F 3-pin. **Ordercode** FL01150 (1,5 m), FL013 (3 m), FL016 (6 m), FL0110 (10 m), FL0115 (15 m), FL0120 (20 m).
- DAP Audio X-type data cable XLR/M 3-pin > XLR/F 3-pin. **Ordercode** FLX0175 (0,75 m), FLX01150 (1,5 m), FLX013 (3 m), FLX016 (6 m), FLX0110 (10 m).
- DAP Audio cable for the demanding user with exceptional audio-qualities and connector made by Neutrik®. **Ordercode** FL71150 (1,5 m), FL713 (3 m), FL716 (6 m), FL7110 (10 m).
- DAP Audio cable for the demanding user with exceptional audio-qualities and connector made by Neutrik®. **Ordercode** FL7275 (0,75 m), FL72150 (1,5 m), FL723 (3 m), FL726 (6 m), FL7210 (10 m).
- DAP Audio 110 Ohm cable with digital signal transmission. **Ordercode** FL0975 (0,75 m), FL09150 (1,5 m), FL093 (3 m), FL096 (6 m), FL0910 (10 m), FL0915 (15 m), FL0920 (20 m).
- DAP Audio DMX adapter: 3-pin/5-pin. **Ordercode** FLA30.

DMX Control Mode

The fixtures are individually addressed on a data-link and connected to the controller. The fixtures respond to the DMX signal from the controller.

DMX Addressing

The optional remote control (**42704**), which is necessary for controlling the fixture, allows you to assign the DMX fixture address, which is the first channel from which the Cameleon Flood will respond to the controller. Please note when you use the controller, the unit has max. **3** channels.

When using multiple Cameleon Floods, make sure you set the DMX addresses right.

Therefore, the DMX address of the first Cameleon Flood should be **1(d001)**; the DMX address of the second Cameleon Flood should be **1+3=4 (d004)**; the DMX address of the third Cameleon Flood should be **4+3=7 (d007)**, etc.

Please, be sure that you don't have any overlapping channels in order to control each Cameleon Flood correctly. If two or more Cameleon Floods are addressed similarly, they will work similarly.

Controlling:

After having addressed all Cameleon fixtures, you may now start operating these via your lighting controller.

Note: After switching on, the Cameleon will automatically detect whether DMX 512 data is received or not. If not, the problem may be:

- The XLR cable from the controller is not connected with the input of the Cameleon.
- The controller is switched off or defective, the cable or connector is defective, or the signal wires are swapped in the input connector.

Note: It is necessary to insert an XLR termination plug (with 120 Ohm) in the last fixture in order to ensure proper transmission on the DMX data link.

Operation via the remote (42704) not included

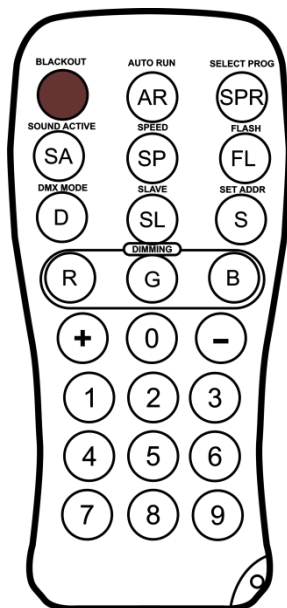

Button	Function	Description
	On / Off	Switch the device ON or OFF
	Auto Mode	Activate Built-in Auto Show mode
	Program Mode	Activate Built-in Programs Show mode
	Sound-controlled Mode	NO function
	Speed Mode	Activate Speed function
	Strobe Mode	Activate Strobe function
	DMX Mode	Activate DMX Mode
	Slave Mode	Activate Slave Mode
	DMX Address	Setting DMX Address
	Red	Activate the Red color/ Static color mode
	Green	Activate the Green color/ Static color mode
	Blue	Activate the Blue color/ Static color mode
	Plus	Increase button
	Minus	Decrease button
	Numeric buttons	Activate the Numeric buttons 0-9

1. Built-in Auto-run mode

- 01) Press the  button to activate the Built-in Auto run mode.
- 02) The Cameleon Flood will automatically start with its built-in program.







2. Built-in programs

- 01) Press the  button to activate the Built-in programs mode.



- 02) With the  buttons you can choose between 6 built-in programs.

Program	Colors
1	No function
2	7-color fade
3	3-color fade
4	Fantasy
5	7-color switch
6	3-color switch
7	Random switch

- 03) In this mode you can control the speed of the program by pressing the  button.
- 04) You can adjust the speed by using the  and  buttons, from slow to fast.
- 05) You can also set the strobe of the program by pressing the  button.
- 06) With the  and  buttons you can change the frequency of the strobe, from low to high.

3. Sound-controlled mode (no function)

This function is not available for outdoor LED fixtures.





4. DMX Mode

- 01) Press the  button to activate the DMX mode, the LEDs will blink once.
- 02) Press the  button to start the DMX Address Setup, the LEDs will blink three times.
- 03) Through these blinking color, the Cameleon Flood indicates its current DMX address.



- 04) With the  buttons you can set the desired DMX address.

Value	Blink Colors
0	White
1	Red
2	Orange
3	Light yellow
4	Green
5	Cyan
6	Blue
7	Purple
8	Pink
9	Yellow

- 05) For example, if you want to set DMX address 184.
- 06) First press the  button, the LEDs will blink three times, meaning you can set the DMX address.
- 07) Press the  button, the LEDs will blink RED, meaning the **1** (hundreds) setting was successful.
- 08) Press the  button, the LEDs will blink PINK, meaning the **8** (tens) setting was successful.
- 09) Press the  button, the LEDs will blink GREEN, meaning the **4** (value 0-9) setting was successful.



All LEDs will flash three times to indicate the entered DMX address.

Note: the maximum operation time to enter one value (one digit) is 6 seconds.

5. Slave mode

01) Press the  button to activate the Slave mode. The device will now operate as a slave device, which means that it will react the same as the master device.

6. Static color mode

01) Press the ,  or  button to activate the Static color mode.

02) With the  buttons you can choose between 10 pre-programmed colors.





Value	Colors
0	White
1	Red
2	Orange
3	Light yellow
4	Green
5	Cyan
6	Blue
7	Purple
8	Pink
9	Yellow

03) You can also set the strobe by pressing the  button.

04) With the  and  buttons you can change the frequency of the strobe, from low to high.

7. Manual color mode

01) Press the ,  or  button to activate the Manual color mode.

02) You can adjust the brightness of the colors by using the  and  buttons. Press the  and  buttons, do not hold down the buttons because this won't function.

03) For example, if you want to decrease the green value.

04) Press the  button, the LEDs will blink green once, indicating that you have selected the green color.



05) Press the  button to decrease the value of green.

06) You can also set the strobe by pressing the  button.

07) With the  and  buttons you can change the frequency of the strobe, from low to high.

8. Factory Reset

01) To return to the factory default setting, first press the  button to turn the light off.

02) When the Cameleon Flood is off (blackout), press the numeric buttons in the sequence ,  and , to return to the factory default settings.

DMX Channels

3 DMX Channels

Channel 1 – Red Dimmer intensity

0-255 Gradual adjustment Red from 0 – 100%

Channel 2 – Green Dimmer intensity

0-255 Gradual adjustment Green from 0 – 100%

Channel 3 – Blue Dimmer intensity

0-255 Gradual adjustment Blue from 0 – 100%

Maintenance

The operator has to make sure that safety-related and machine-technical installations are to be inspected by an expert after every year in the course of an acceptance test.

The operator has to make sure that safety-related and machine-technical installations are to be inspected by a skilled person once a year.

The following points have to be considered during the inspection:

- 01) All screws used for installing the device or parts of the device have to be tightly connected and must not be corroded.
- 02) There may not be any deformations on housings, fixations and installation spots.
- 03) Mechanically moving parts like axles, eyes and others may not show any traces of wearing.
- 04) The electric power supply cables must not show any damages or material fatigue.

The Cameleon Flood 7/3 RGB requires almost no maintenance. However, you should keep the unit clean. Otherwise, the fixture's light-output will be significantly reduced. Disconnect the mains power supply, and then wipe the cover with a damp cloth. Do not immerse in liquid. Wipe lens clean with glass cleaner and a soft cloth. Do not use alcohol or solvents.

The front lens will require weekly cleaning, as smoke-fluid tends to build up residues, reducing the light-output very quickly.

Keep connections clean. Make sure connections are thoroughly dry before linking equipment or supplying electric power.

Troubleshooting

This troubleshooting guide is meant to help solve simple problems.

If a problem occurs, carry out the steps below in sequence until a solution is found. Once the unit operates properly, do not carry out following steps.

No Light

If the light effect does not operate properly, refer servicing to a technician.

Suspect three potential problem areas as: the power supply, the LEDs, the internal fuse.

- 01) Power supply. Check that the unit is plugged into an appropriate power supply.
- 02) The LEDs. Return the Cameleon Flood to your Showtec dealer.
- 03) The internal fuse. Return the Cameleon Flood to your Showtec dealer.
- 04) If all of the above appears to be O.K., plug the unit in again.
- 05) If you are unable to determine the cause of the problem, do not open the Cameleon Flood, as this may damage the unit and the warranty will become void.
- 06) Return the device to your Showtec dealer.

No Response to DMX

Suspect the DMX cable or connectors, a controller malfunction, a light effect DMX card malfunction.

- 01) Check the DMX setting. Make sure that DMX addresses are correct.
- 02) Check the DMX cable: Unplug the unit; change the DMX cable; then reconnect to electrical power. Try your DMX control again.
- 03) Determine whether the controller or light effect is at fault. Does the controller operate properly with other DMX products? If not, take the controller in for repair. If so, take the DMX cable and the light effect to a qualified technician.

Problem	Probable cause(s)	Solution
One or more fixtures do not function at all	No power to the fixture	<ul style="list-style-type: none"> • Check if power is switched on and cables are plugged in
	Internal fuse blown	<ul style="list-style-type: none"> • Return the Cameleon Flood to your Showtec dealer
Fixtures reset correctly, but all respond erratically or not at all to the controller	The controller is not connected.	<ul style="list-style-type: none"> • Connect controller.
	3-pin XLR Out of the controller does not match XLR Out of the first fixture on the link (i.e. signal is reversed)	<ul style="list-style-type: none"> • Install a phase reversing cable between the controller and the first fixture on the link
Fixtures reset correctly, but some respond erratically or not at all to the controller	Poor data quality	<ul style="list-style-type: none"> • Check data quality. If much lower than 100 percent, the problem may be a bad data link connection, poor quality or broken cables, missing termination plug, or a defective fixture disturbing the link
	Bad data link connection	<ul style="list-style-type: none"> • Inspect connections and cables. Correct poor connections. Repair or replace damaged cables
	Data link not terminated with 120 Ohm termination plug	<ul style="list-style-type: none"> • Insert termination plug in output jack of the last fixture on the link
	Incorrect addressing of the fixtures	<ul style="list-style-type: none"> • Check address setting
	One of the fixtures is defective and disturbs data transmission on the link	<ul style="list-style-type: none"> • Bypass one fixture at a time until normal operation is restored: unplug both connectors and connect them directly together. • Have the defective fixture serviced by a qualified technician
	3-pin XLR Out on the fixtures does not match (pins 2 and 3 reversed)	<ul style="list-style-type: none"> • Install a phase-reversing cable between the fixtures or swap pin 2 and 3 in the fixture that behaves erratically
No light or LEDs cuts out intermittently	Fixture is too hot	<ul style="list-style-type: none"> • Allow the fixture to cool down • Clean the fan • Make sure air vents in control panel and the front lens are not blocked • Turn up the air conditioning
	LEDs damaged	<ul style="list-style-type: none"> • Disconnect the fixture and return it to your dealer
	The power supply settings do not match local AC voltage and frequency	<ul style="list-style-type: none"> • Disconnect fixture. Check settings and correct if necessary

Product Specifications

Model:	Showtec Cameleon Flood 7/3 RGB
Input Voltage:	100-240 VAC, 50/60Hz Autoswitch
Power consumption:	21W (full output)
Protection rate:	IP-65
Dimensions:	170 x 70 x 128 mm (LxWxH incl. bracket)
Weight:	1,1 kg
Operating and Programming:	
Signal pin OUT:	Pin 1 (earth), pin 2 (-), pin 3 (+)
DMX Mode:	3 channels
Signal input:	3-pin DMX IN
Signal output:	3-pin DMX OUT
Electro-mechanical effects:	
LED Quantity:	7x 3-in-1 3W RGB LEDs
Beam angle:	40°
Colour range:	16,7 million additive colors RGB Colormixing
Lens Plate:	Tempered Glass
Connections:	Dedicated Power cable IP-65 IN/OUT & Data IP-65 IN/OUT
Dimmer:	0-100%
Strobe:	0-20Hz
Control:	DMX / Auto Program / Built-in programs / Master-slave / IR remote
Cooling:	Convection (no fans)
Housing:	Die Cast Aluminum black powder coat finish
Max. ambient temperature t_a :	40°C
Max. housing temperature t_B :	80°C
Minimum distance:	
Minimum distance from flammable surfaces:	0,5 m
Minimum distance to lighted object:	1 m

Design and product specifications are subject to change without prior notice.



Website: www.Showtec.info
Email: service@highlite.nl

Dimensions

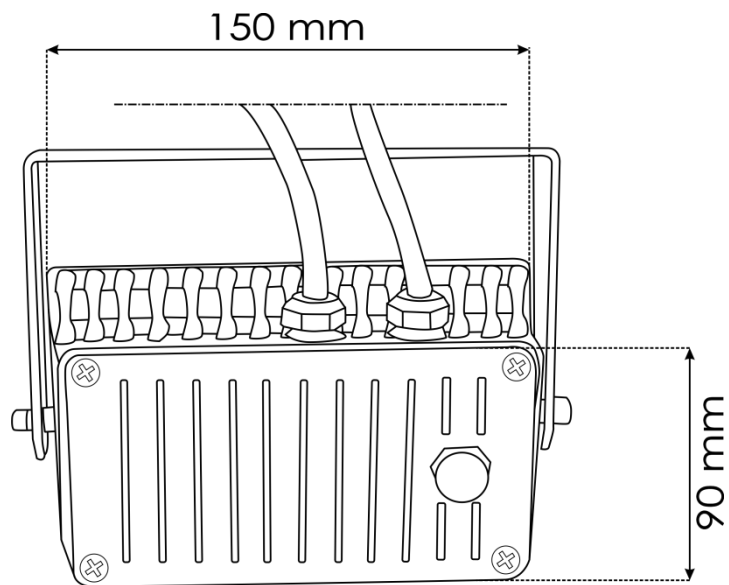
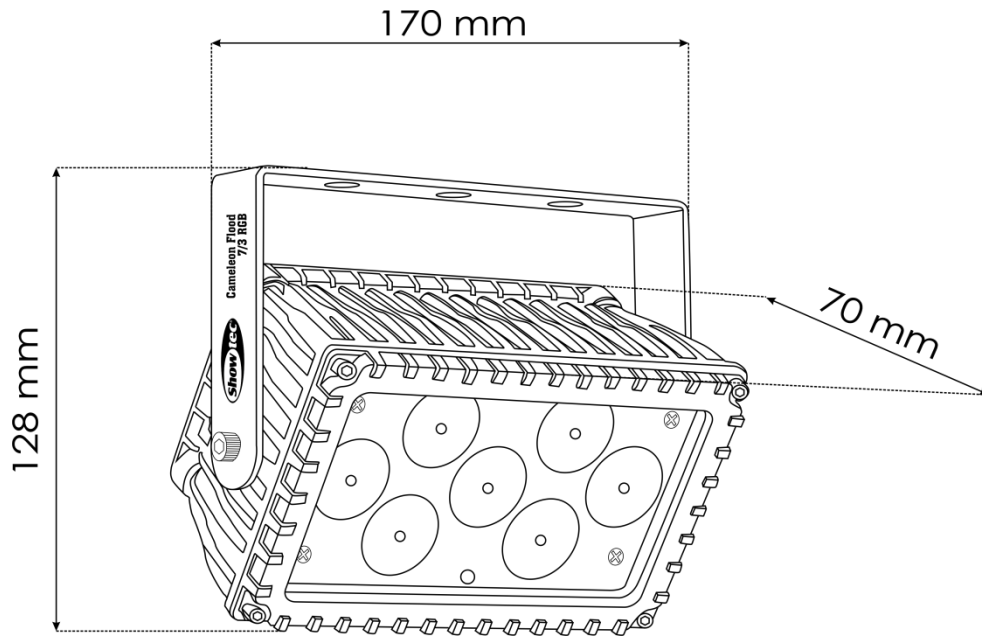



©2016 Showtec